













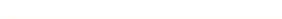







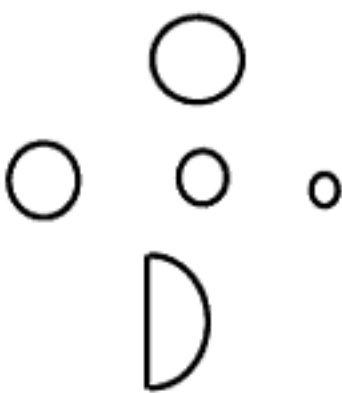
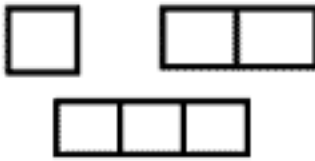

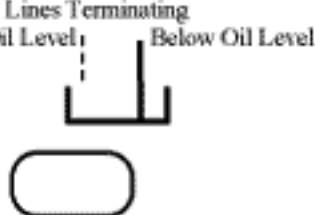



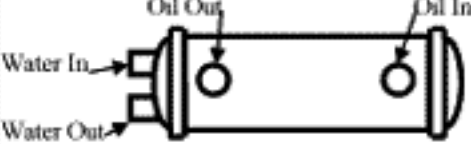
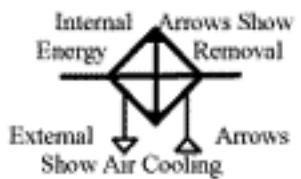
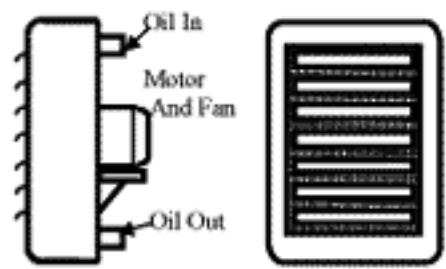
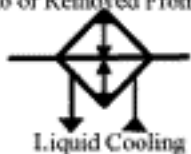
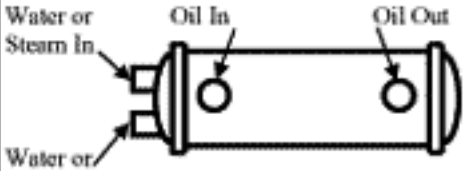
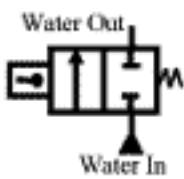
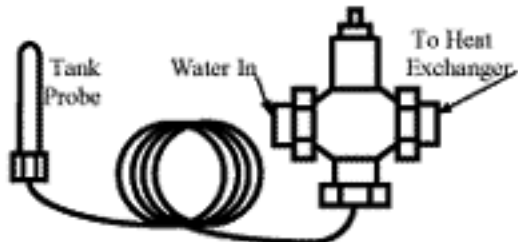

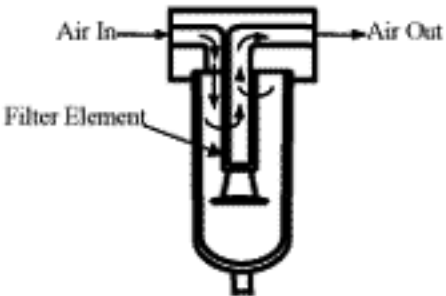
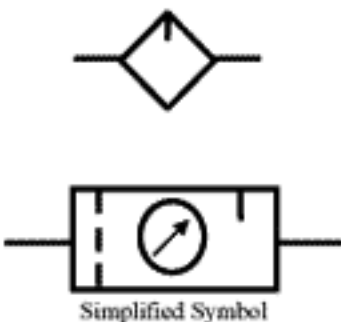
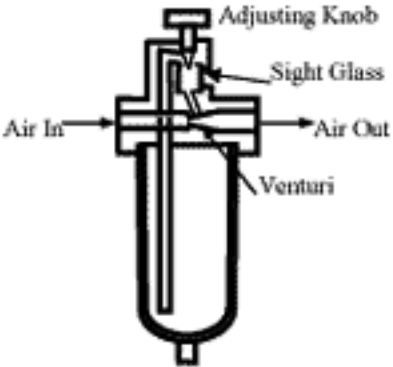
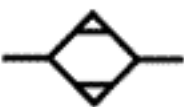
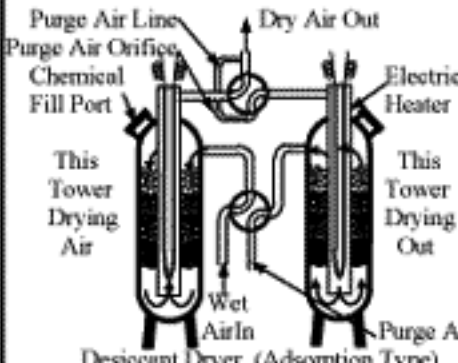
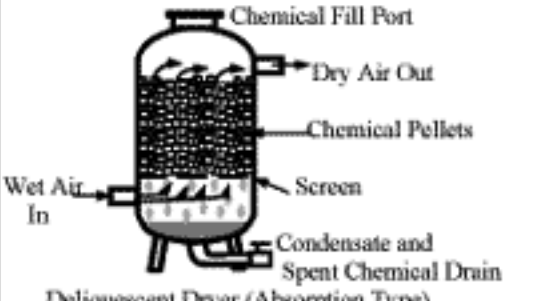
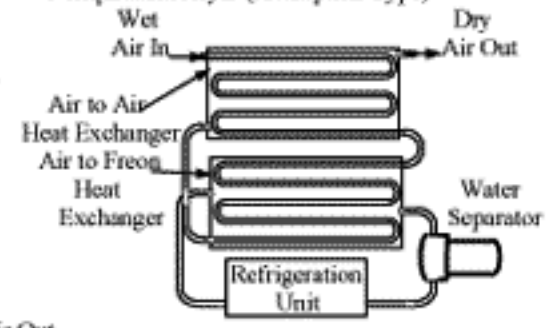



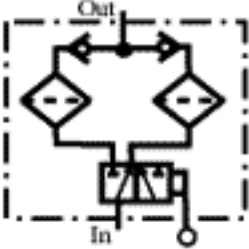

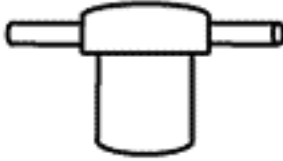
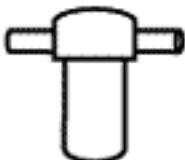
ISO Designation	Symbol	Picture Representation
Basic Information Lines Continuous Non-Flowing Pump Flow Tank Flow Suction Flow Metered Flow Reduced Pressure Intensified Fluid	Black  Red  Blue  Green  Yellow  Orange  Purple 	<p>Represents a working fluid line. This fluid comes from a prime mover and goes to the actuator to perform work. May be a 1/8" plastic air line or any size pipe or tube in a hydraulic system.</p> <p style="text-align: center;">COLOR CODING FOR OVERHEADS</p>
Long Dashes	Orange 	<p>Represents pilot lines that supply a small amount fluid to another valve or device making it operate. The length of these dashes should be at least ten times their thickness .</p>
Short Dashes	Green 	<p>Represents drain lines for hydraulic circuits. Many hydraulic valves have internal leakage that can get trapped and cause a malfunction .A drain line is a small line giving trapped fluid a free flow path to tank. The length of these dashes is five times their thickness.</p>
Double Lines		<p>Represents a mechanical connection Between components, A pump motor shaft, feedback connections between valves and actuators, etc. The outside dimension of these lines should be at least five times the line thickness.</p>
Center Line		<p>Represents an enclosure outline that indicates the parts inside it are a unit. This unit may be a casting with the parts machined in it or it might be a several components assembly.</p>
Electric Line		<p>Denotes a line carrying electrical power or signal.</p>

ISO Designation	Symbol	Picture Representation
Flexible Line		Shows hose or other flexible line. Could be whole length or only a portion of the conduit.
Pipe Junction		Denotes a tee or cross where lines connect to one another. The connecting Dot is always used with the Jumper below. Preferred way.
Pipe Junction		Denotes pipes connecting at a tee or cross. Optional way.
Pipes Crossing		Denotes pipes crossing. Preferred way
Pipes Crossing		Denotes pipes crossing. Optional way
Plug		
Air Bleed		Shows a connection for bleeding trapped air
Pressure Takeoff		A connection for taking power from a line or for pressure testing. Shown plugged.
Pressure Takeoff		With takeoff line connected .
Energy Triangle		Pneumatic Shows direction of flow and type of fluid. Hydraulic
Power Source		Denotes a power source from another part of the schematic or a another source
Power Source		General
Power Source		Pneumatic
Power Source		Hydraulic
Arrows		Indicates direction of rotation of a pump or motor shaft, valve actuator or other actuator.
Arrows		Indicates direction of movement of a component.
Arrows		Arrows used for flow direction in valves. Arrows with a perpendicular line opposite the arrow head
Arrows		Arrows with a perpendicular line at the head end indicates the path stays connected to its outlet when it moves
Sloping Arrow		A sloping arrow through a pump, valve, spring, cushion plunger, solenoid or other device indicates it is adjustable or variable.

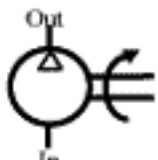
ISO Designation	Symbol	Picture Representation
Circles and Semi-circles		<p>Represents a rotary device such as a pump or motor. Denotes the device is capable of continuous rotation in one or both directions.</p> <p>Circles of different sizes are the basis of unit of measurement instruments such as gauges. Also represents mechanical rollers on cam operated valves.</p> <p>Semi-circles denote rotary output devices that are not capable of continuous rotation. These actuators only oscillate through some arc.</p>
Squares and Rectangular Boxes (Envelopes)		<p>Square or rectangular boxes or envelopes are the basic unit of pressure and directional control valves. Single boxes denote pressure controls while multiple boxes show directional controls. The valve operator box is also a rectangle</p>
Diamond Shaped Boxes		<p>Diamond shaped boxes indicate a fluid conditioning device like a filter, lubricator, or heat exchanger.</p>
Miscellaneous Symbols		<p>A sawtooth line represents a spring.</p> <p>Back to back semi-circles on a line show a standard orifice that is affected by viscosity.</p> <p>Back to back "V" on a line denotes an orifice that is not affected by viscosity.</p>
Reservoirs Chapter 6 Reservoir Open To Atmosphere Pressurized Reservoir	<p>Lines Terminating</p> <p>Above Oil Level Below Oil Level</p> 	<p>Breather Filler Cap</p>  <p>Sight Gauge Clean Out Cover</p> <p>For systems that operate in contaminated locations or when using pressure to force fluid flow.</p>
Heaters Chapter 6 Tank Heater	 <p>Arrows Show Energy Entering Fluid Flow</p>	 <p>Heating Rods Temp. Control</p> <p>Electric Heating Unit</p>
Heat Exchangers (Coolers) Chapter 6 Water Cooled Heat exchanger	 <p>Internal Energy Arrows Show Removal</p> <p>External Show Liquid Cooling</p>	 <p>Oil Out Oil In</p> <p>Water In Water Out</p> <p>Shell and Tube Heat Exchanger</p>

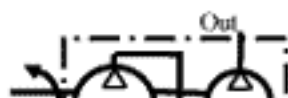

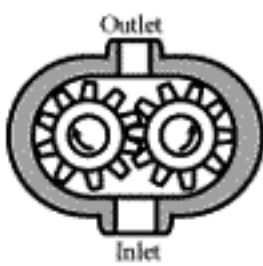

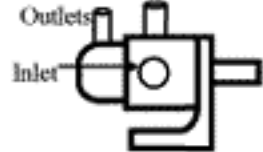
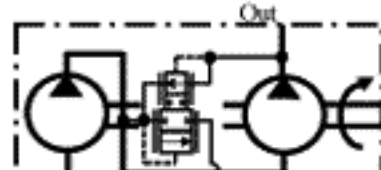
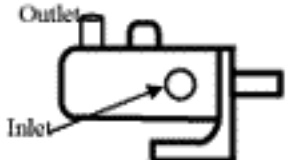
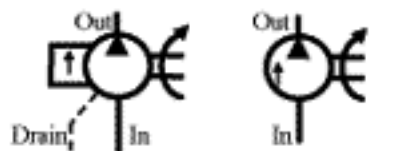
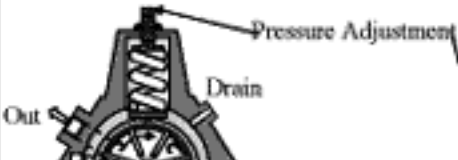
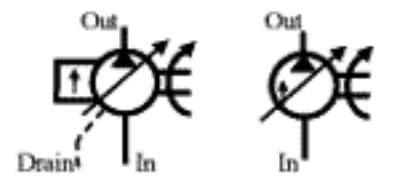
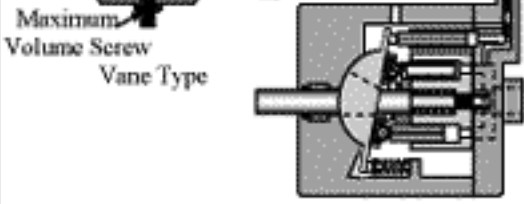
ISO Designation	Symbol	Picture Representation
<p>Heat Exchangers (Coolers) Chapter 6</p> <p>Air Cooled Heat Exchanger</p>		 <p>Fan Cooled Radiator Type Heat Exchanger</p>
<p>Temperature Controller Chapter 6</p>	<p>Internal Arrows Show Energy Added to or Removed From Fluid Flow</p>  <p>Liquid Cooling</p>	 <p>Shell and Tube Temperature Controller</p>
<p>Temperature Controlled Water Valve Chapter 6</p>		 <p>Temperature Controlled Water Valve</p>
<p>Air Line Filter Chapter 7</p>	 <p>With Manual Drain</p> <p>With Automatic Drain</p>	
<p>Air Line Lubricator Chapter 7</p> <p>Air Line Filter, Regulator and Lubricator Chapter 7</p>	 <p>Simplified Symbol</p>	

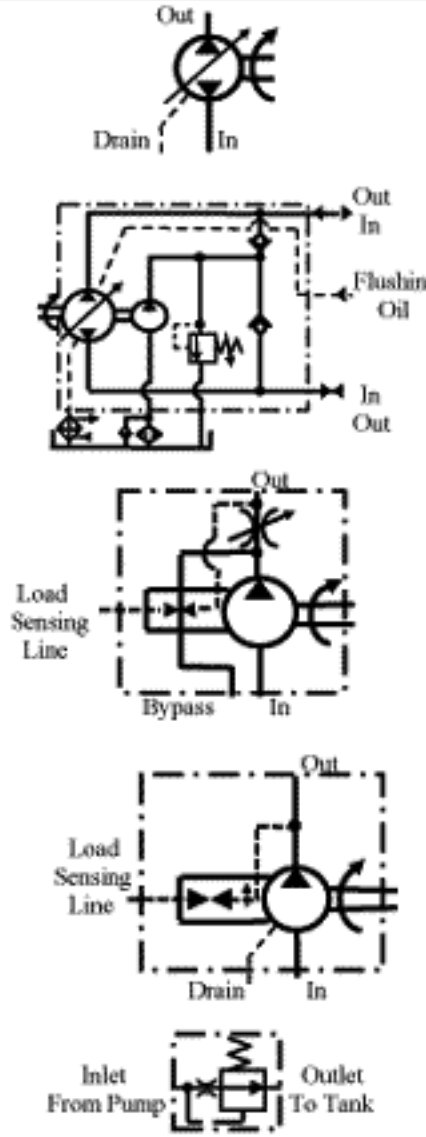
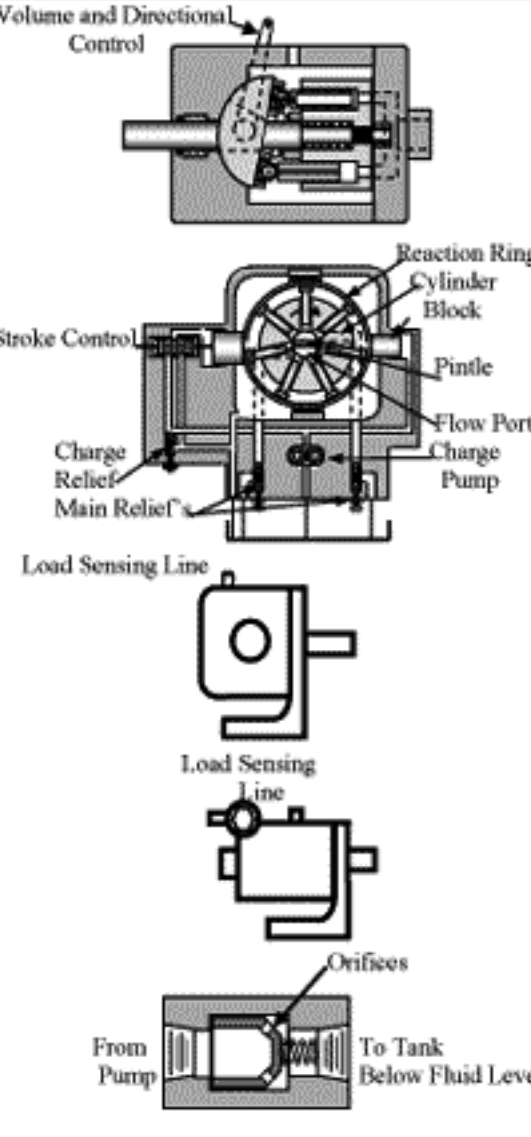
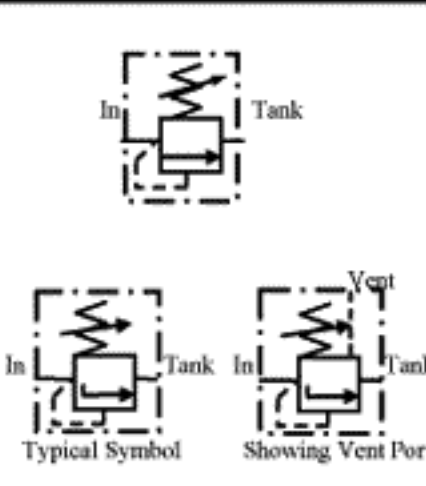
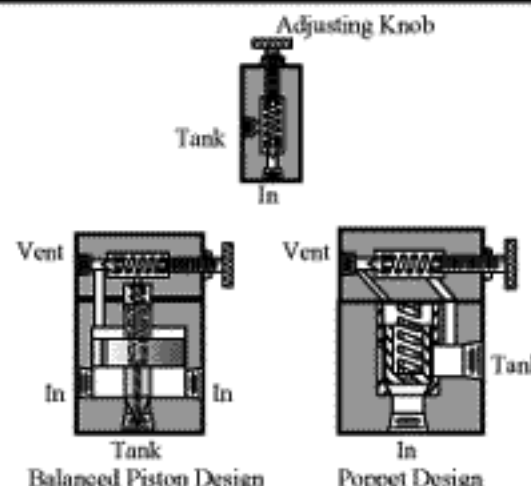

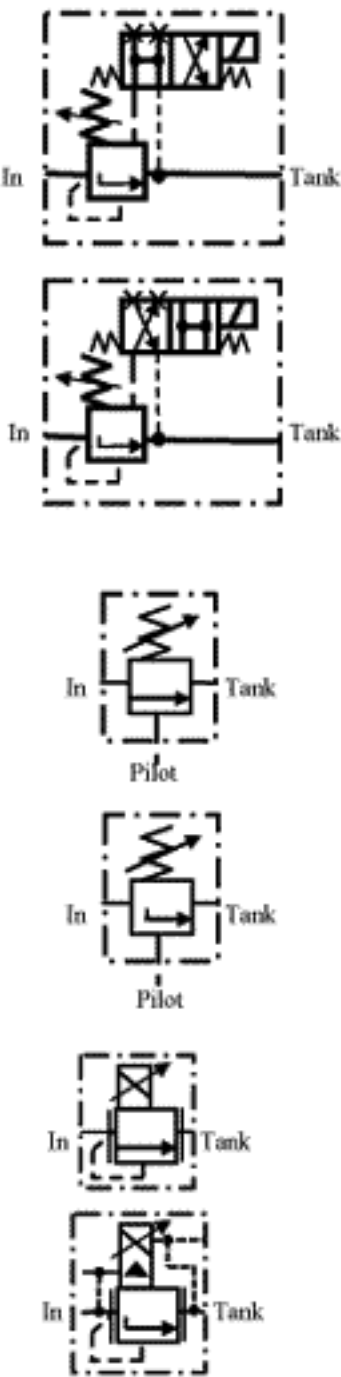
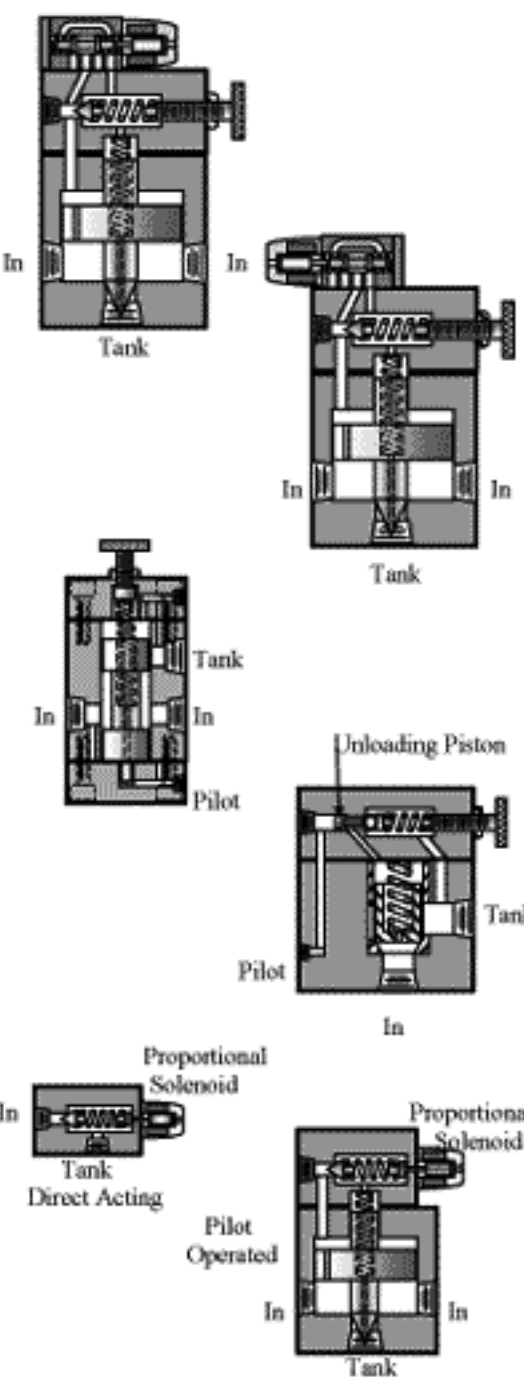
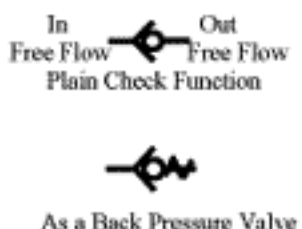
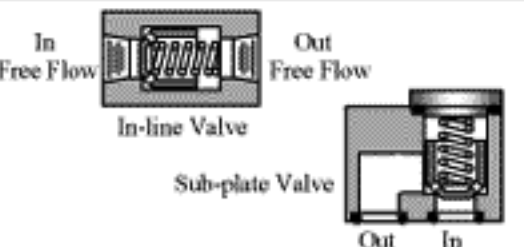

ISO Designation	Symbol	Picture Representation
Air Dryer Chapter 7	  Desiccant Dryer (Adsorption Type)	 Deliquescent Dryer (Absorption Type)  Refrigeration Dryer (Condensing Type)
Hydraulic Filters Chapter 7 In Tank Hydraulic Suction Strainer With Bypass In-Line Return Filter With Bypass In-Line Pressure Filter Without Bypass Dual Pressure Filter For Changing Elements While Circuit is Running	   	 Built-in Bypass Check Valve In Tank Type Suction Strainer   

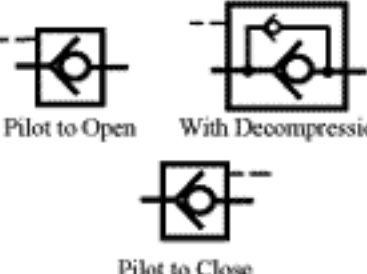
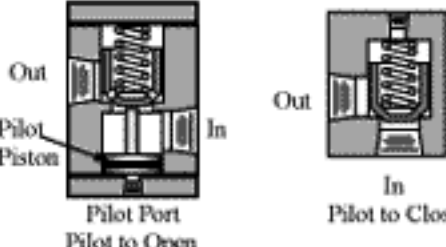

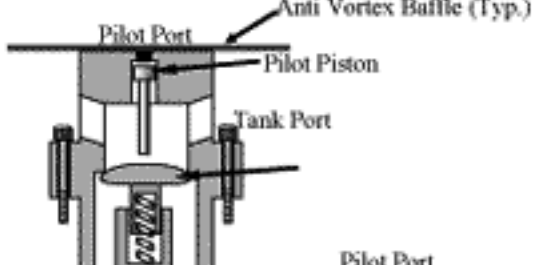
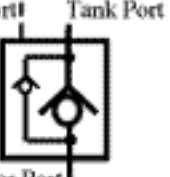
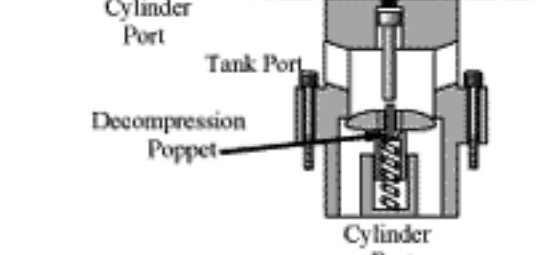
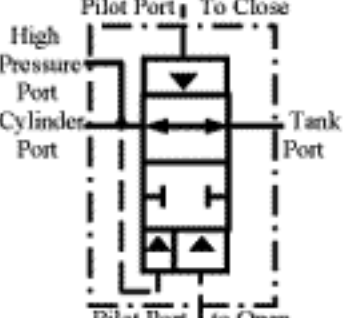
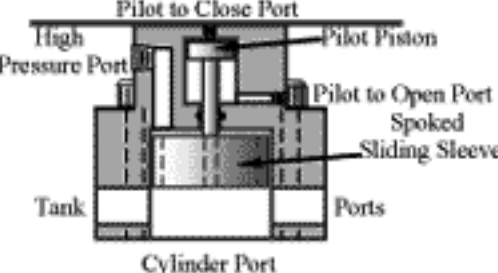
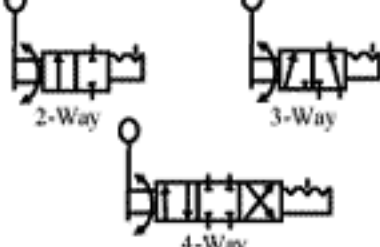
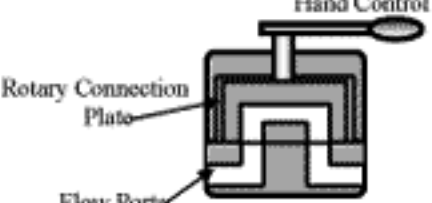

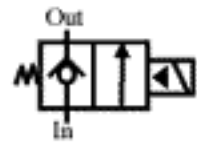
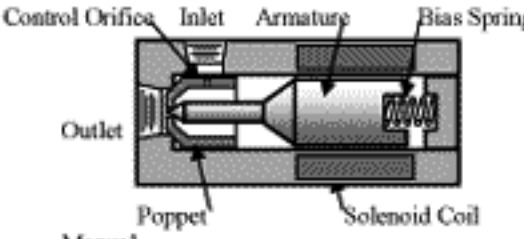
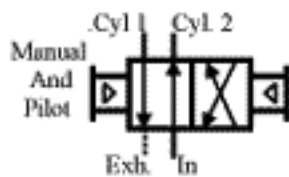
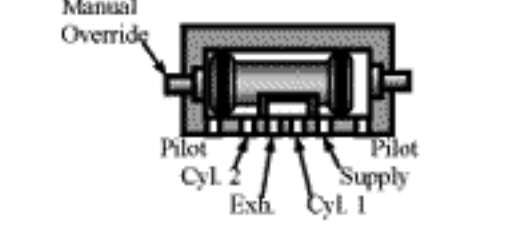

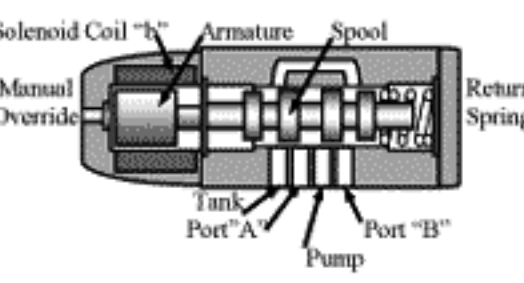
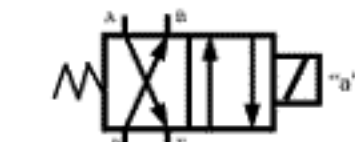
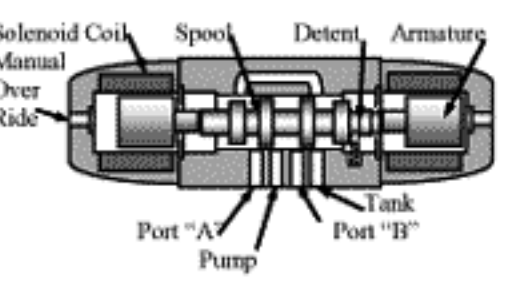
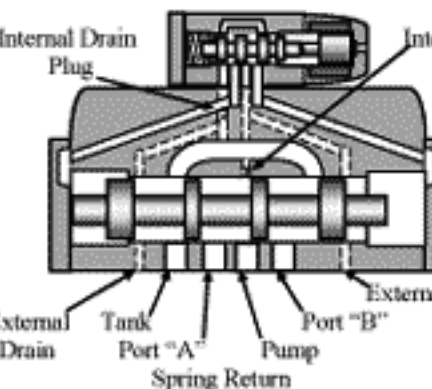
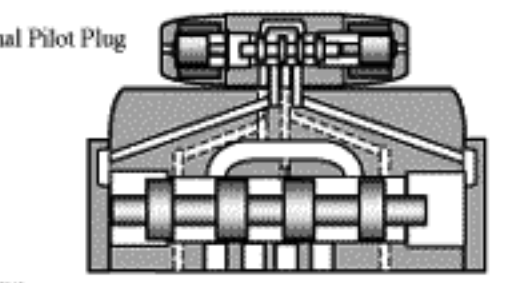
ISO Designation	Symbol	Picture Representation
Pumps Chapter 8 Air Pump Single Stage (Compressor)		
Air Pump Two Stage (Compressor)		
Hydraulic Pump Fixed Volume Single Flow Single Stage		
Hydraulic Pump Fixed Volume Double Flow Single Stage		
Hydraulic Pump Fixed Volume Single Flow Two Stage		
Hydraulic Pump Pressure Compensated Single Flow Single Stage		
Hydraulic Pump Pressure Compensated Variable Volume Single Flow Single Stage		

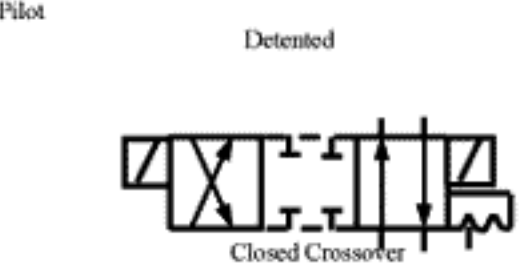
ISO Designation	Symbol	Picture Representation
<p>Pumps (Cont'd.)</p> <p>Hydraulic Pump Variable Volume Bi-directional Flow Single Stage</p> <p>Hydraulic Pump Variable Volume Bi-directional Single Stage With Charge Pump For Closed Loop Circuits</p> <p>Hydraulic Pump Fixed Volume Single Flow Single Stage With Load Sensing</p> <p>Hydraulic Pump Pressure Compensated Single Flow Single Stage With Load Sensing</p> <p>Air Bleed Valve for closed center circuits to let trapped air escape from pump outlet</p>		
<p>Relief and Unloading Valves Chapter 9</p> <p>Relief Valve Direct Acting Adjustable</p> <p>Relief Valve Pilot Operated Adjustable With Vent Port</p>		

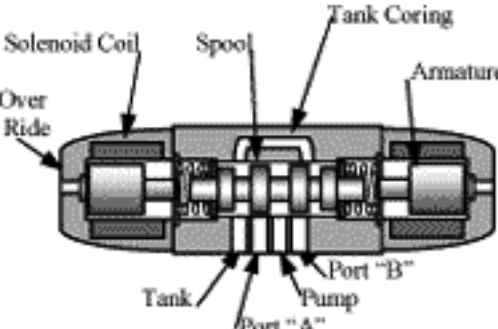
ISO Designation	Symbol	Picture Representation
<p>Relief and Unloading Valves (Cont'd.)</p> <p>Solenoid Operated Relief Valve Normally Open</p> <p>Solenoid Operated Relief Valve Normally Closed</p> <p>Unloading Valve External Pilot Operated Direct Acting</p> <p>Unloading Valve External Pilot Operated Pilot Operated Also Used as an Accumulator Circuit Pump Unloading Valve Through Unloading Spool</p> <p>Proportional Relief Valve Direct Acting</p> <p>Proportional Relief Valve Pilot Operated</p>		
<p>Directional Control Valves Chapter 10</p> <p>Check Valves Inline, Sub-plate Mounted, Screw In Cartridge</p>	 <p>As a Back Pressure Valve</p>	

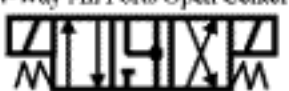
ISO Designation	Symbol	Picture Representation
Directional Control Valves (Cont'd.)		
Orificed Check Valve		
Pre-fill Valves Without Decompression Feature		
With Decompression Feature		
Sliding Sleeve Pre-fill Valve		
Rotary Shear Valve		

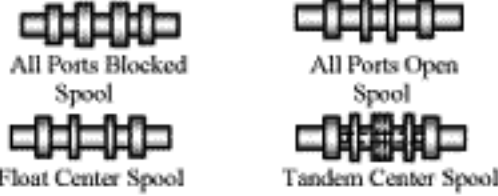
ISO Designation	Symbol	Picture Representation
Directional Control Valves (Cont'd.)		
Poppet Type Valve		
Sliding Plate Valve		
Spool Type Valve		
4-Way 2 Position Valve Spring Return Direct Acting Solenoid		
4-Way 2 Position Valve Detented Direct acting Solenoid		
4-Way 2 Position Valve Spring Return and Detented Solenoid Pilot Operated		
2 Position Valve Typical Transition or Crossover Condition		

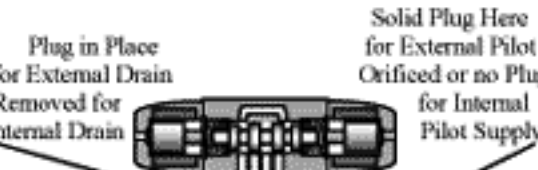
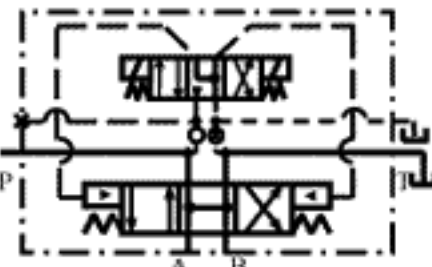
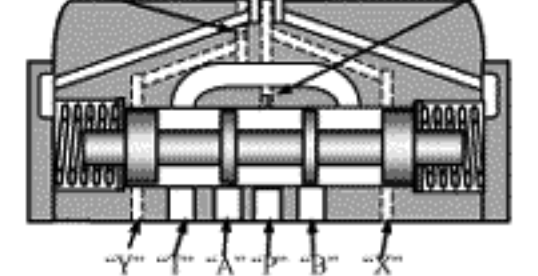
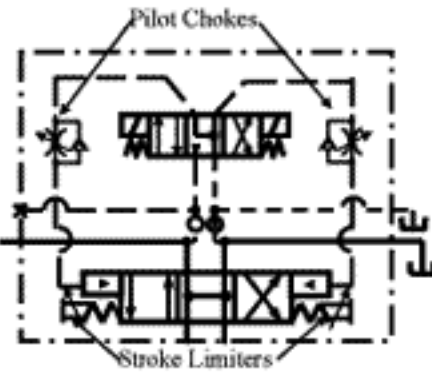
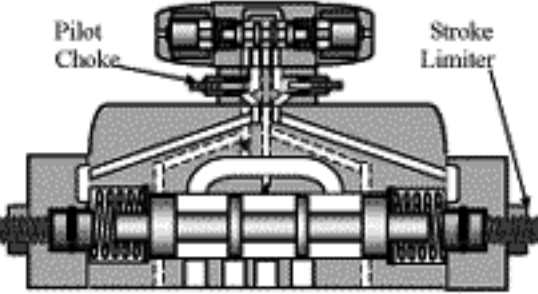
ISO Designation	Symbol	Picture Representation
Directional Control Valves (Cont'd.)		
Spool Type Valves	 Manual	
Direct Solenoid Operated, Three Position, Spring Centered Directional Control Valves	 4-Way All Ports Open Center  4-Way Float Center  4-Way Tandem Center	
	Four Standard Center Conditions	
Solenoid Pilot Operated Three Position, Spring Centered Directional Control Valve	 Simplified Symbol	
	 Complete Symbol	
Solenoid Pilot Operated, Three Position, Spring Centered Directional Control Valves With Pilot Chokes and Main Spool Stroke Limiting Screws		

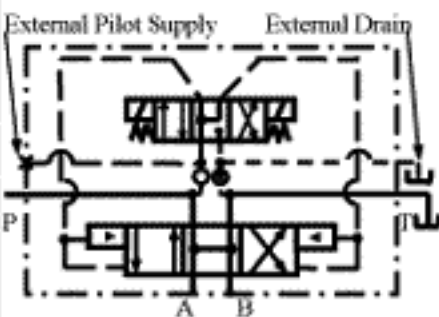
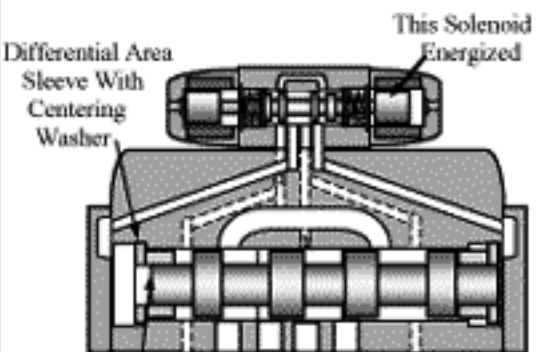
ISO Designation	Symbol	Picture Representation
<p>Directional Control Valves (Cont'd.)</p> <p>Solenoid Pilot Operated, Three Position, Hydraulic Centered, Directional Control Valve</p>	 <p>External Pilot Supply External Drain</p> <p>Complete Symbol Internal Pilot Supply, External Drain</p>	 <p>Differential Area Sleeve With Centering Washer</p> <p>This Solenoid Energized</p> <p>Shifting Area Valve Shown in Shifted Condition</p>



Other Available Center Conditions From Most Manufacturers

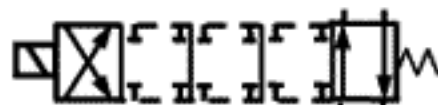

4-Way 2 Position Single Solenoid
All Ports Blocked Center

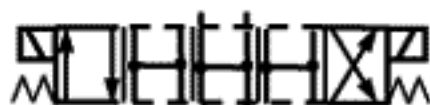

4-Way 3 Position Double Solenoid Spring Centered
All Ports Open Center



Float Center



Tandem Center



Pump "A" and "B" Connected
Tank Blocked



Pump "A" and Tank Connected
"B" Blocked



Pump "B" and Tank Connected
"A" Blocked

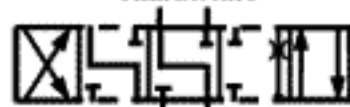

Pump and "B" Blocked
"A" to Tank



Pump and "A" Blocked
"B" to Tank



Open Center Orificed Flow



Float Center Orificed Flow

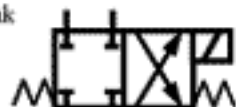

Single Solenoid Spring Centered
At Rest in Center Condition Shift to Flow Path

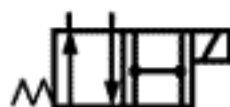

Single Solenoid Spring Return
At Rest in Flow Path, Shift to a Center Condition

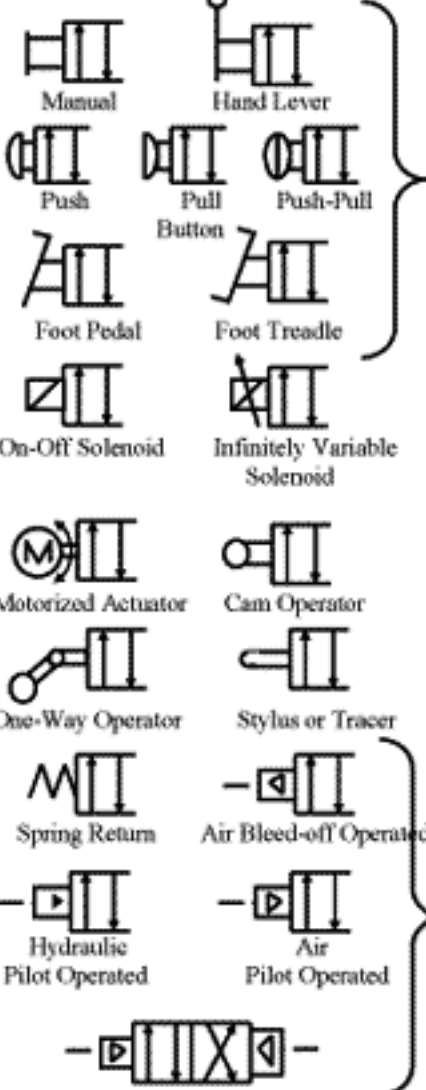
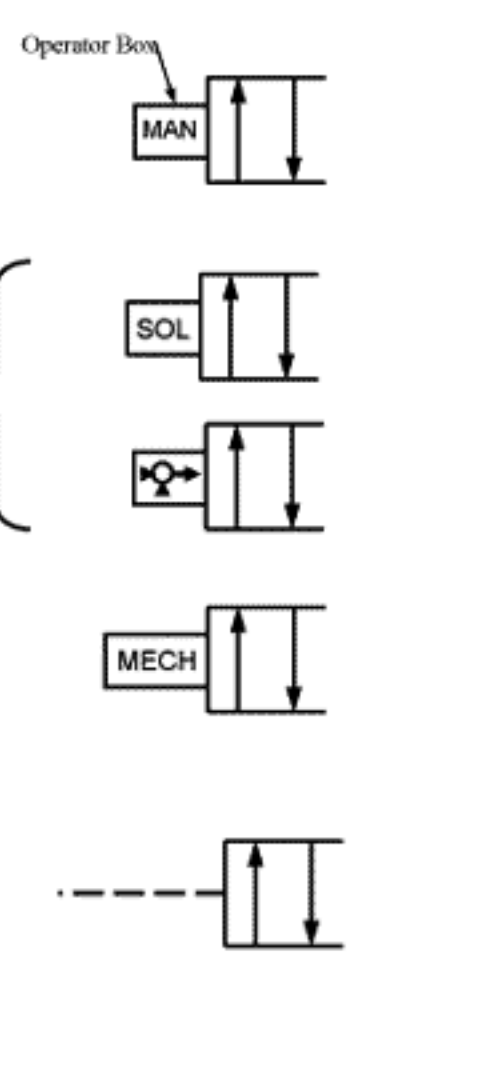
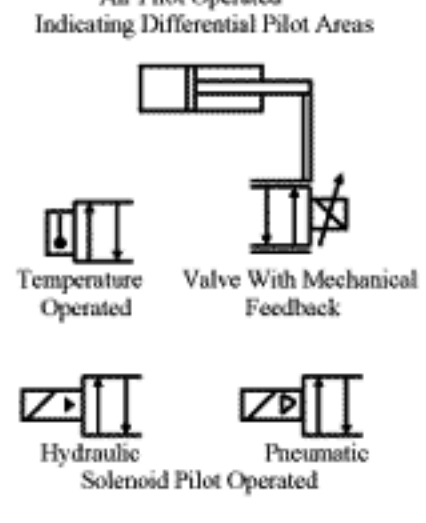
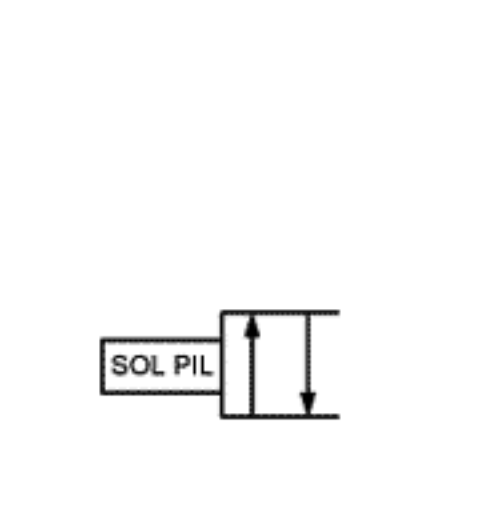
ISO Designation	Symbol	Pre 1966 ANSI Symbol
Directional Control Valves (Cont'd) Valve Operators	 <p>Manual Hand Lever</p> <p>Push Pull Push-Pull</p> <p>Button</p> <p>Foot Pedal Foot Treadle</p> <p>On-Off Solenoid Infinitely Variable Solenoid</p> <p>Motorized Actuator Cam Operator</p> <p>One-Way Operator Stylus or Tracer</p> <p>Spring Return Air Bleed-off Operated</p> <p>Hydraulic Pilot Operated Air Pilot Operated</p> <p>Air Pilot Operated Indicating Differential Pilot Areas</p>	 <p>Operator Box</p> <p>MAN</p> <p>SOL</p> <p>MECH</p>
Valve Operators	 <p>Temperature Operated Valve With Mechanical Feedback</p> <p>Hydraulic Solenoid Pilot Operated Pneumatic Solenoid Pilot Operated</p>	 <p>SOL PIL</p>

ISO Designation	Symbol	Picture Representation
-----------------	--------	------------------------

Directional Control Valves (Cont'd.)
NFPA AND ISO STANDARD INTERFACE LAYOUTS FOR HYDRAULIC DIRECTIONAL CONTROL VALVES

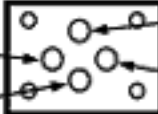
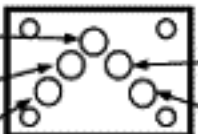
NFPA	ISO	CETOP	NG	PORT DIA	PORT CONFIGURATION	NOMINAL FLOW
D02	02	2	4	.177		5 GPM
D03	03	3	6	.295		10 GPM
D05	05	5	10	.440		20 GPM

All Views Shown Looking Into Ports On The Valve

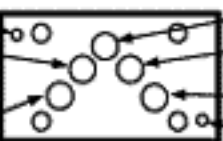
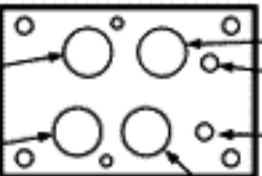
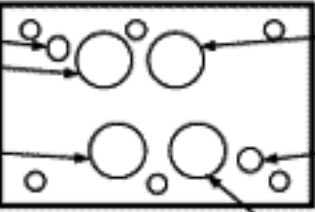
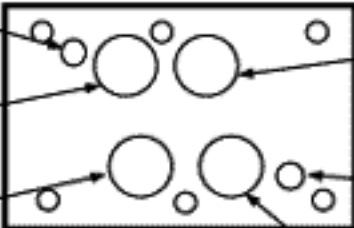
D05H	05			.440		25 GPM
D07	07	7	16	.690		30 GPM
D08	08	8	25	.984		60 GPM
D10	10	10	32	1.250		100 GPM

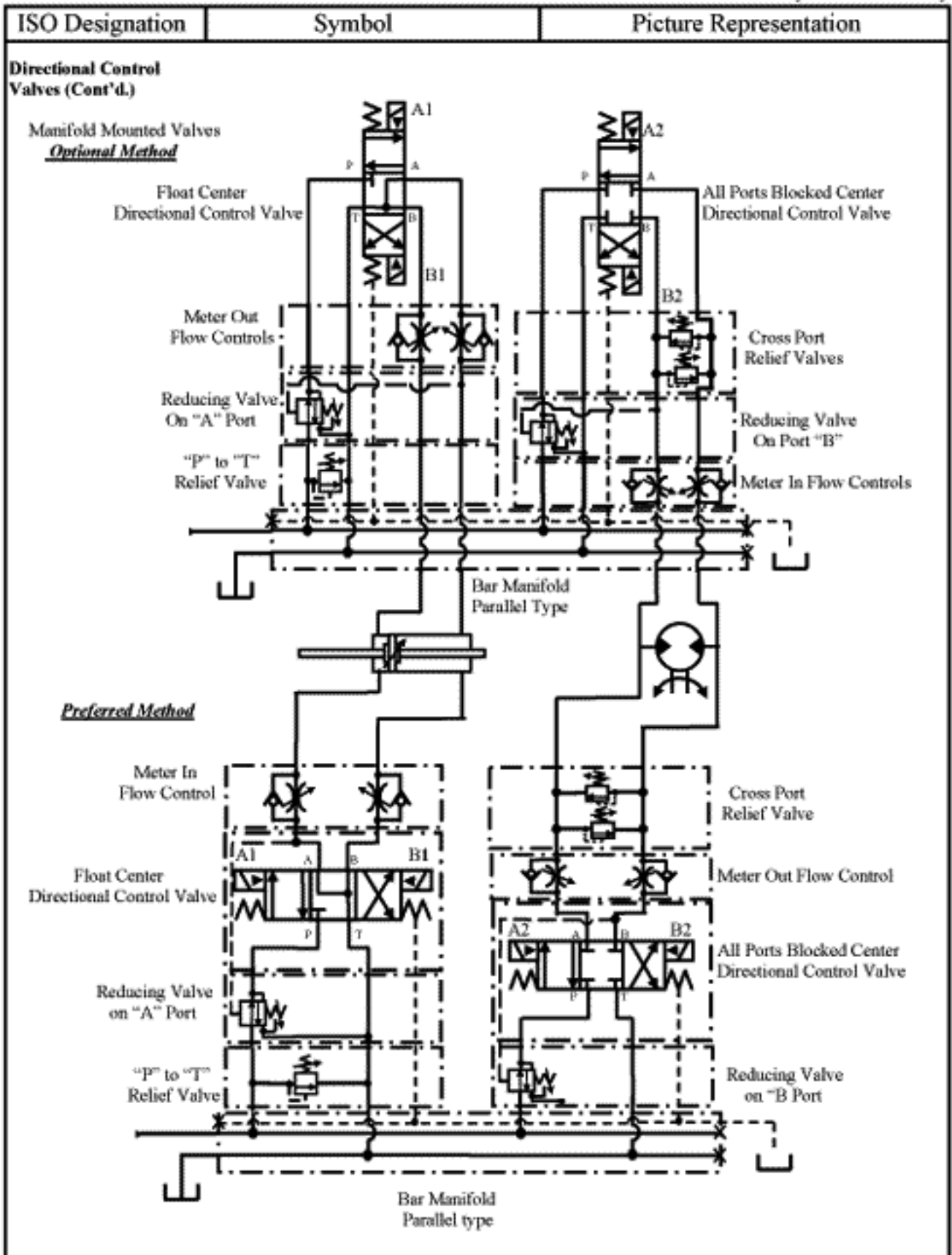

ISO Designation

Symbol

Picture Representation

Directional Control Valves (Cont'd.)

Screw-in Cartridge Valves, All the same functions as In-line and Sub-Plate mounted Valves.

5-Way Air Pilot Operated, Spring Return Air Valve, Poppet Type

5-Way Solenoid Air Pilot Operated, Spring Return Air Valve, Spool Type

1:1 Poppet Ratio used for Pressure Control

1:1 Poppet Ratio as a Relief Valve

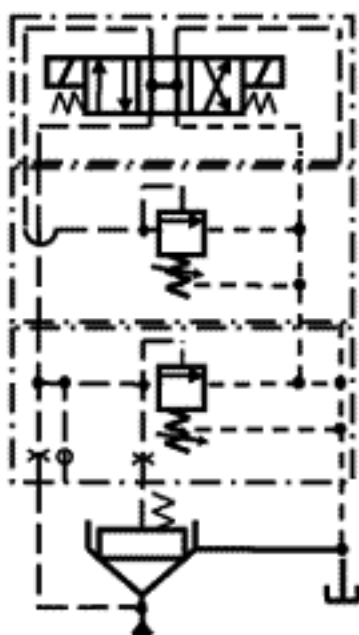
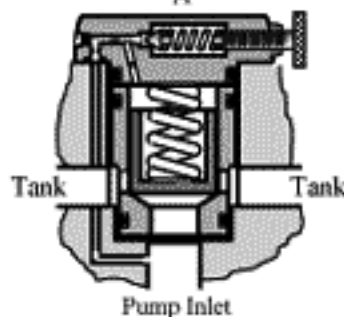
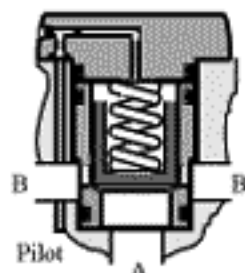
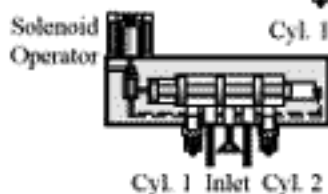
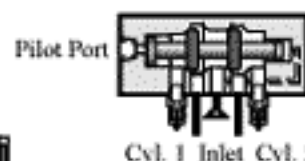
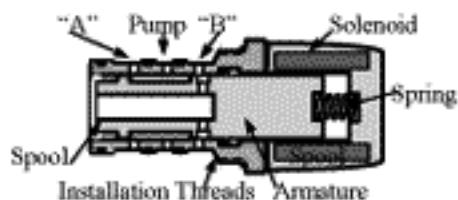
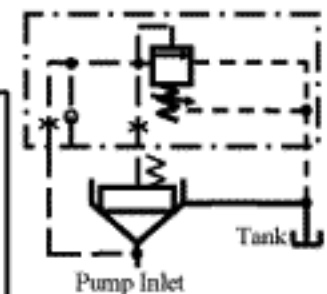
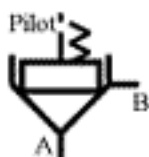
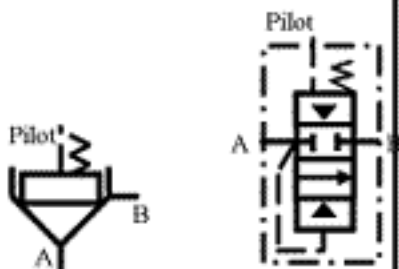
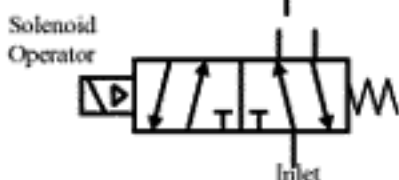
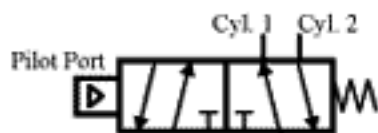

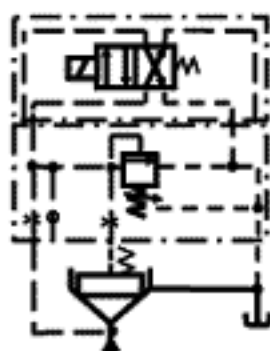

Dual-Pressure and Pump Unload and Relief Valve



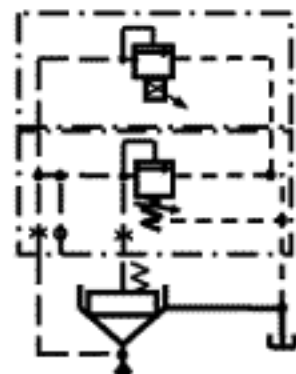

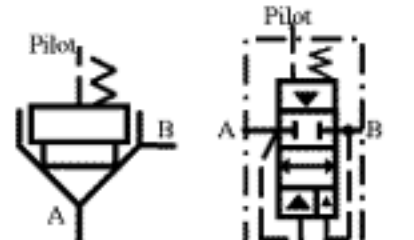
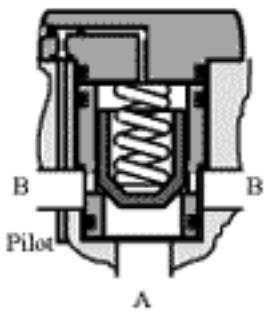
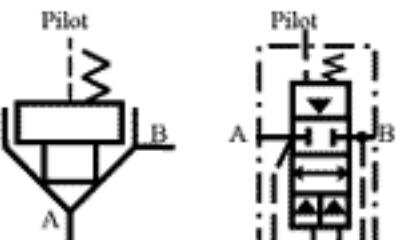
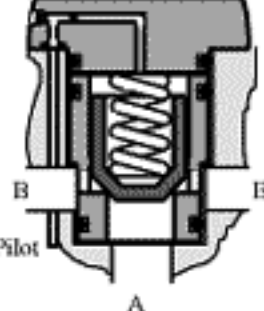
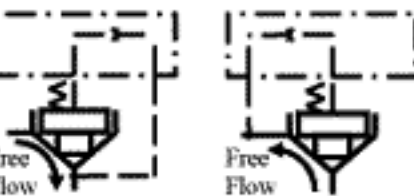
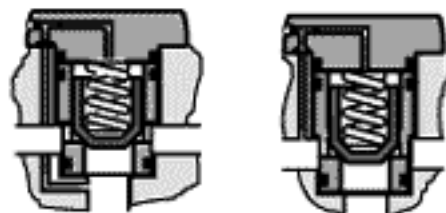
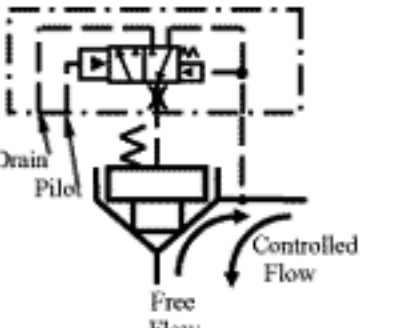
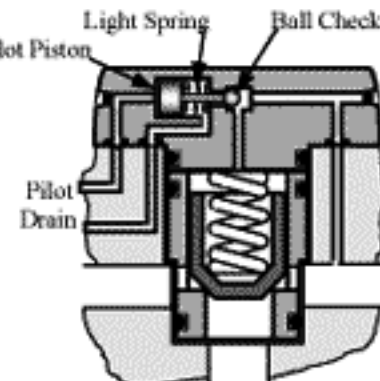

Normally open Solenoid Operated Relief Valve

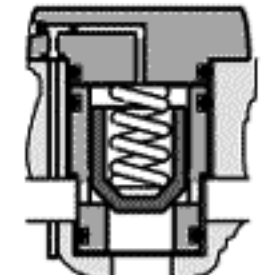

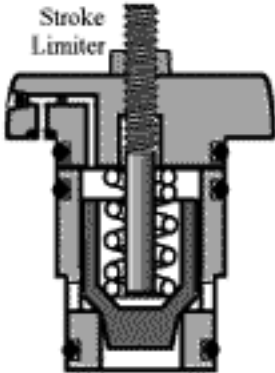
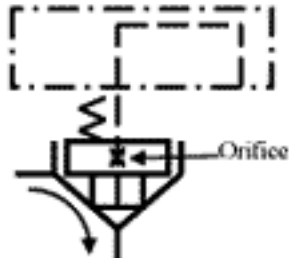
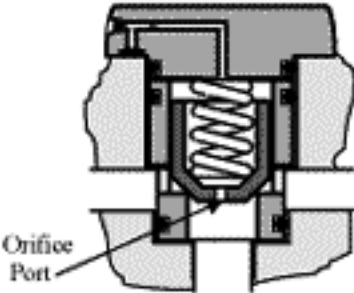
Proportional Relief Valve

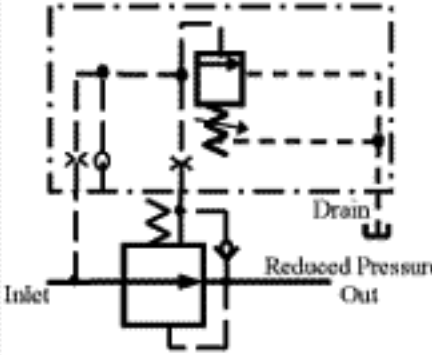
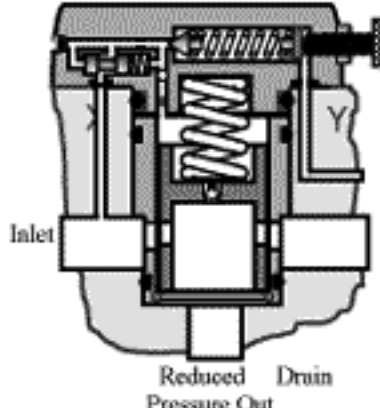
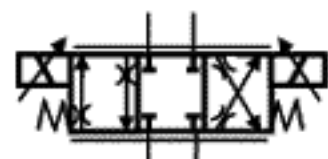
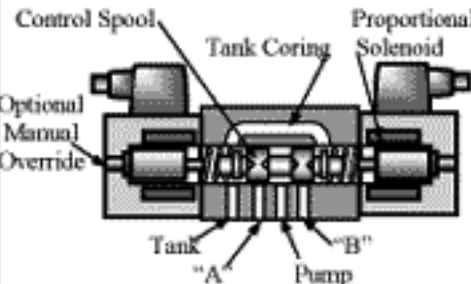

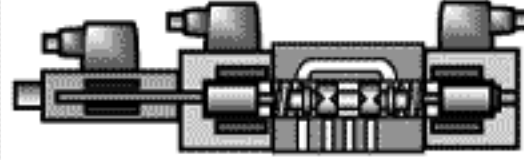
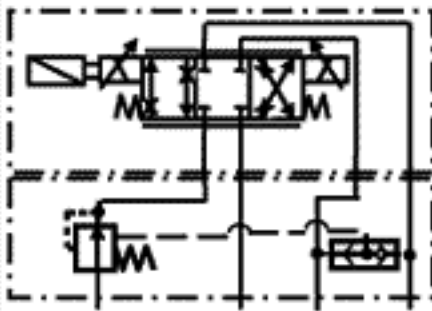
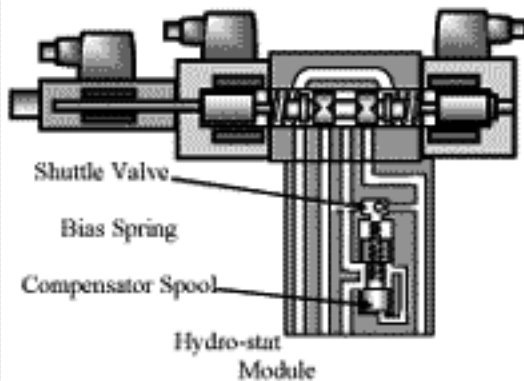
ISO Designation	Symbol	Picture Representation
Slip-in Cartridge Valves (Cont'd.) 1:1.1 Poppet Ratio Used for Pressure Control or Directional Control	 <p>Frequently Used Symbol</p> <p>Symbol using ISO Rules</p>	 <p>A</p>
1:2 Poppet Ratio Used For Directional Control	 <p>Frequently Used Symbol</p> <p>Symbol using ISO Rules</p>	 <p>A</p>
1:2 Poppet Ratio as a Check Valve With Plain Cover and Internal Connection	 <p>Free Flow</p> <p>Free Flow</p>	
1:2 Pilot Ratio as a Pilot Operated Check Valve With Pilot Operated Check Valve Cover	 <p>Drain Pilot</p> <p>Pilot</p> <p>Controlled Flow</p> <p>Free Flow</p>	 <p>Light Spring</p> <p>Ball Check</p> <p>Pilot Piston</p> <p>Pilot Drain</p>
1:2 Pilot Ratio as a Directional Control Valve With Plain Cover and External Connection		





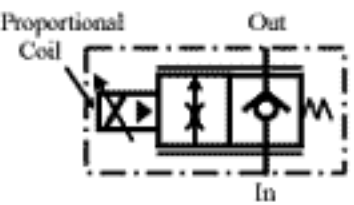
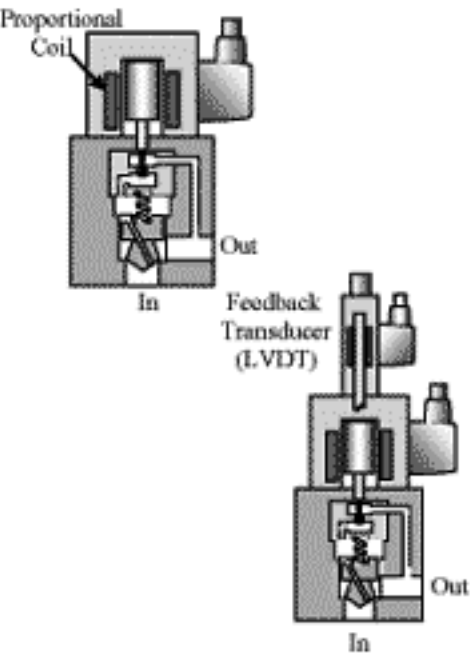
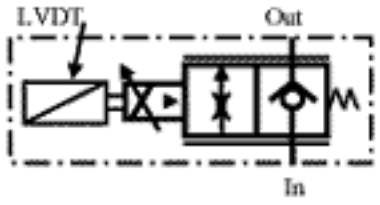
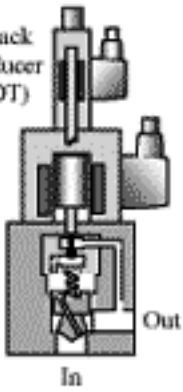
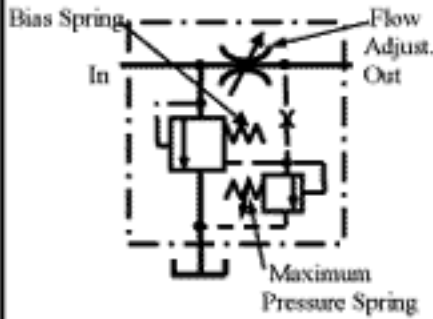
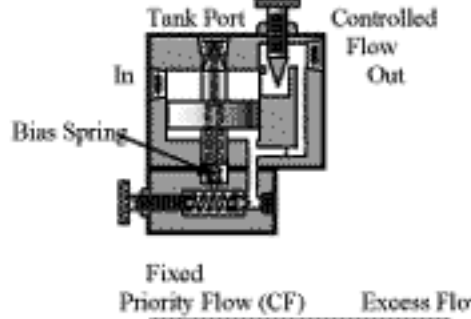
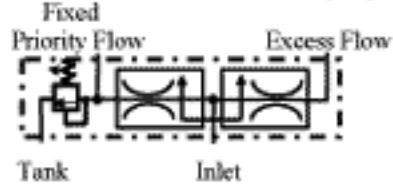
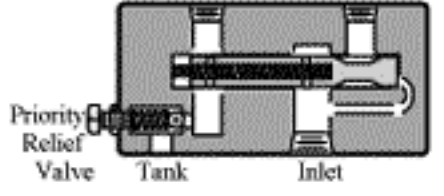
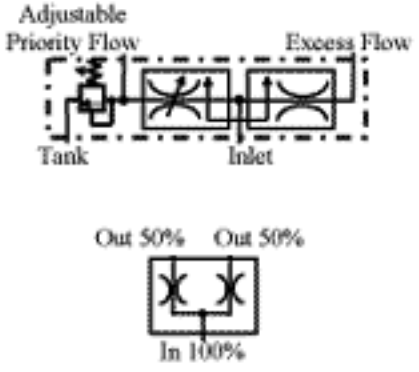
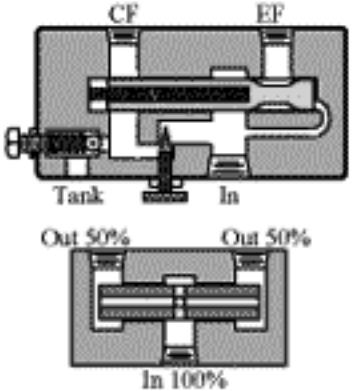

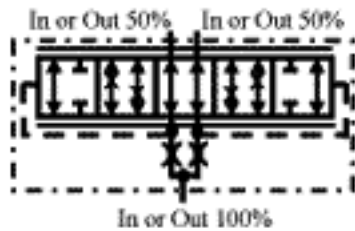
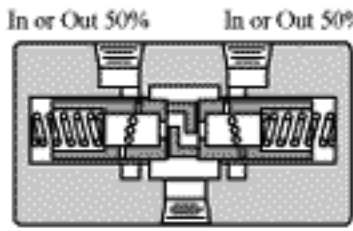
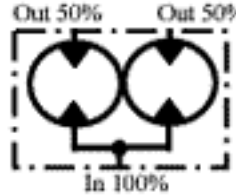
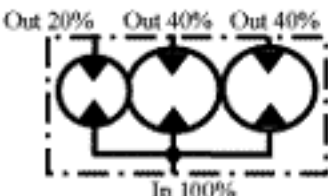
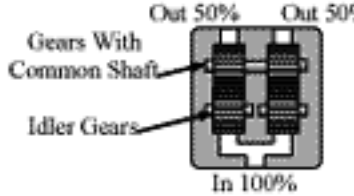
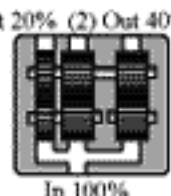
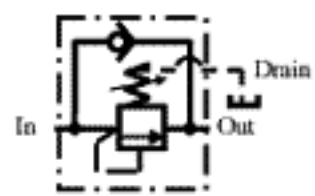
ISO Designation	Symbol	Picture Representation
<p>Slip-in Cartridge Valves (Cont'd.)</p> <p>1:2 Pilot Ratio as:</p>	<p>Single Solenoid Normally Open</p> <p>Double Solenoid Spring Centered Normally Open</p>	<p>Double Solenoid Detented Normally Open</p> <p>Double Solenoid Spring Centered Normally Closed</p>
<p>Slip-in Cartridge Valve With Stroke Limiter and Deceleration Skirts</p>	<p>Stroke Limiter</p> 	
<p>Slip-in Cartridge valve With Orifice port As a Check Valve</p>		

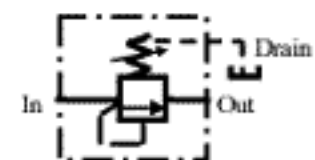
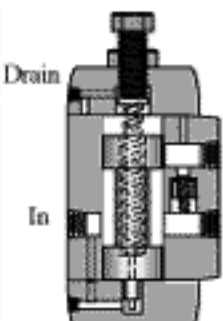
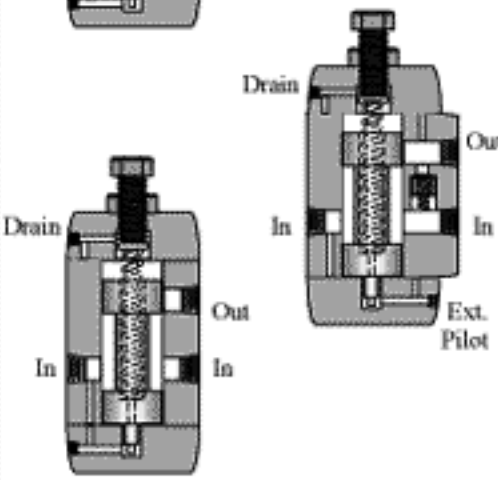
ISO Designation	Symbol	Picture Representation
<p>Slip-in Cartridge Valves (Cont'd.)</p> <p>Slip-in Cartridge Valve as a Reducing Valve</p>		
<p>Infinitely Variable Directional Valves Chapter 12</p> <p>Proportional Controls</p> <p>Direct Solenoid Operated Without Spool Position Feedback</p>		
<p>Direct Solenoid Operated With Spool Position Feedback</p>		
<p>Direct Solenoid Operated With Spool Position Feedback and Pressure Compensating Module (Hydro-Stat)</p>		
<p>Simplified Symbol for a Solenoid Pilot Operated Valve With Spool Position Feedback</p>		<p>SEE NEXT PAGE PROPORTIONAL VALVE COMPLETE SYMBOL.</p>

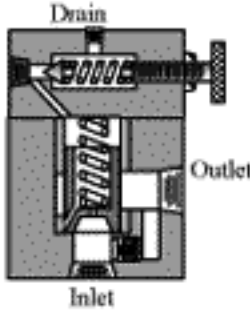
ISO Designation	Symbol	Picture Representation
<p>Infinitely Variable Directional Valves (Cont'd.)</p> <p>Complete Symbol for a Solenoid Pilot Operated Valve With Spool Position Feedback</p>		
<p>Servo Valves</p>	<p>ANSI Symbol</p> <p>ISO Symbol</p>	
<p>Flow Control Valves Chapter 13</p>	<p>Affected by Viscosity</p> <p>Un-affected by Viscosity</p>	<p>Standard Orifice</p> <p>Knife Edge Orifice</p>
<p>Fixed Orifice</p>		
<p>Needle Valve</p>		
<p>Non-Compensated Flow Control Valve</p>	<p>ANSI Symbol</p> <p>ISO Symbol</p>	
<p>Pressure and Temperature Compensated Flow Control</p>		

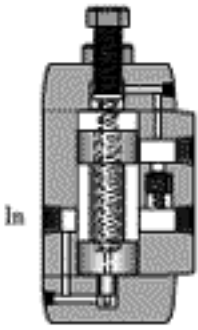
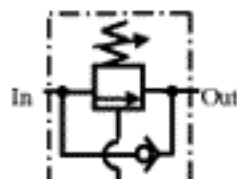
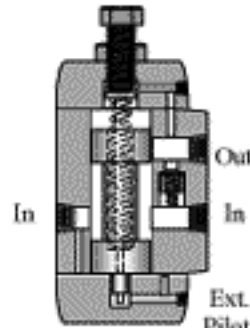
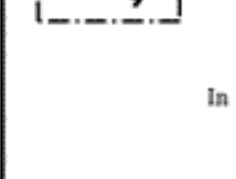
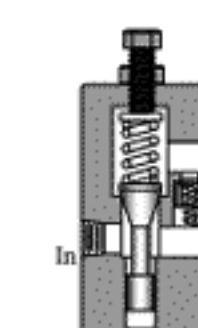
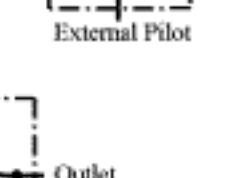
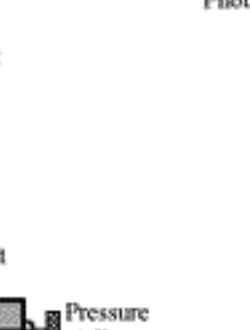
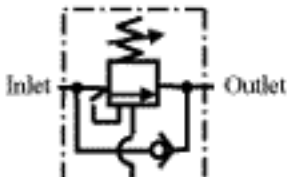
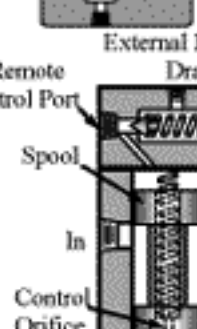
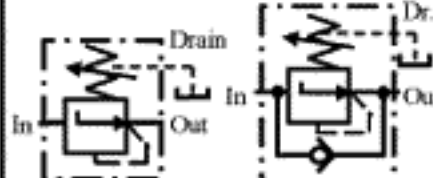
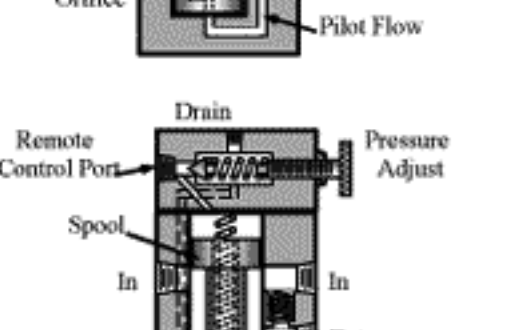
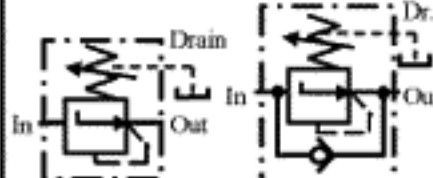
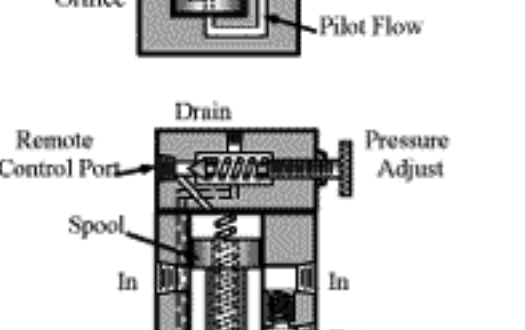
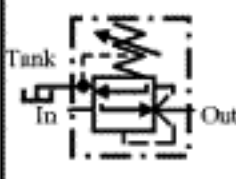
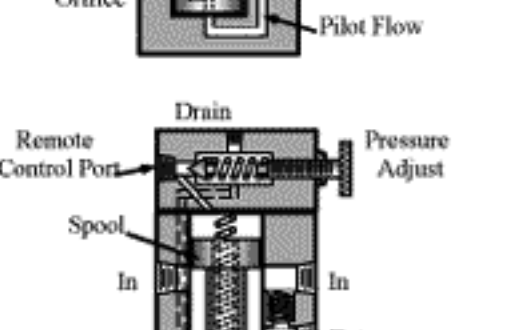
ISO Designation	Symbol	Picture Representation
<p>Flow Control Valves (Cont'd.)</p> <p>Proportional Flow Control Valves Without Feedback</p>		
<p>With Feedback</p>		
<p>Three Port Flow Control With Built-in Relief Valve. Also Called a Bypass Flow Control. Bypass Flow Cannot be Used to do Work</p>		
<p>Priority Type Three Port Flow Control Bypass Flow can be Used to do Work</p>		
<p>Flow Dividers Spool Type One Direction Only</p>		

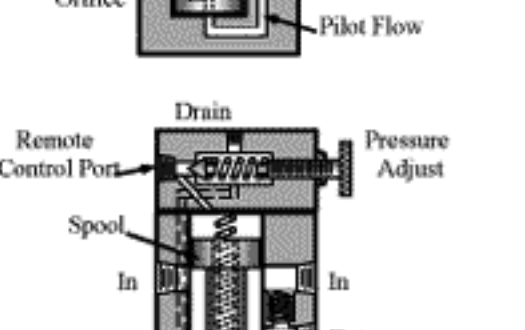
ISO Designation	Symbol	Picture Representation
<p>Flow Control Valves (Cont'd.)</p> <p>Flow Dividers Spool Type Bi-directional (Functional Symbol)</p>		
<p>Flow Dividers Motor Type</p>	 	 
<p>Pressure Control Valves Chapter 14 (Except Relief and Unloading Valves)</p> <p>Sequence Valve</p> <p>Internal Pilot</p> <p>External Pilot</p> <p>Internal Pilot Without Check Valve</p>	  	 

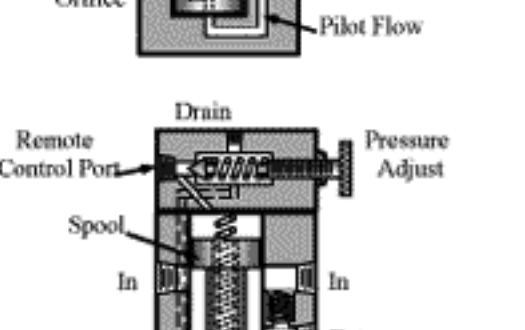
ISO Designation	Symbol	Picture Representation
Pressure Control Valves (Except Relief and Unloading Valves) (Cont'd.)		
Kick Down Sequence Valve		
Counter Balance Valve		
Internal Pilot Internal Drain		
External Pilot Internal Drain		
Internal and External Pilot, Internal Drain		
Reducing Valves		
Reducing Only With and Without Bypass Check		
Reducing, Relieving Without Bypass Check		
With Bypass Check		
With External Drain		

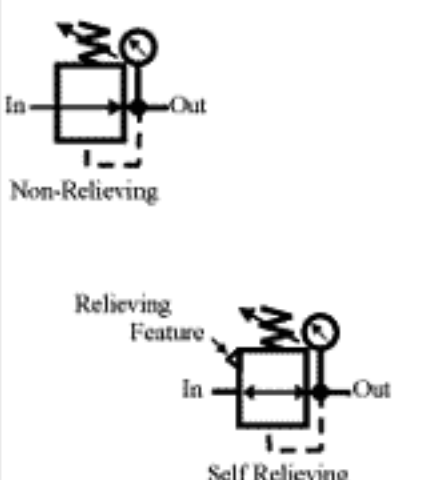
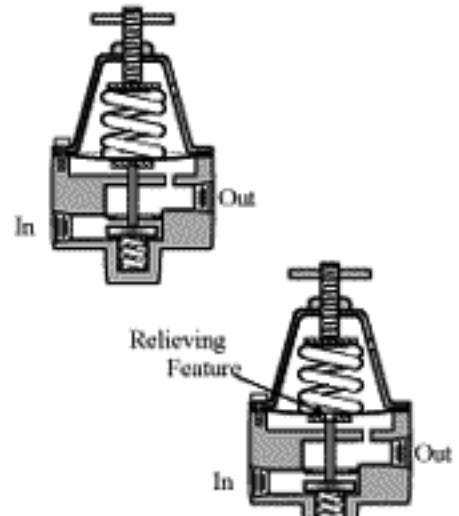
ISO Designation	Symbol	Picture Representation
<p>Pressure Control Valves (Except Relief and Unloading Valves) (Cont'd.) Air Line Regulator (Reducing Valve)</p>		
<p>Actuators Chapter 15</p> <p>Single Acting Rams</p> <p>Push Type</p> <p>The Inlet Port Can be Anyplace on the Body The Only Seals are Where the Rams Exit The Body.</p> <p>Pull Type May Have a Cover Over the Top Ram to Protect Personnel</p> <p>Single Acting Telescoping</p> <p>Double Acting Telescoping</p> <p>Single Acting Spring Return</p>	